

Greenhouse

EN DE CZ SK HU PL

GZ 59 - 2,5 x 3,1 m

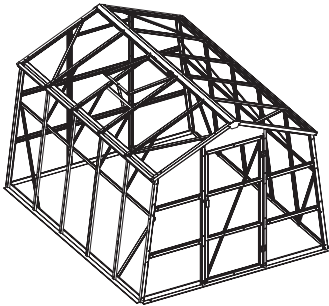

۲۱



Thank you for purchasing our product.

Before using this unit, please read this manual.

Assembly instructions:

Prior to the assembly please read all instructions and information carefully. The greenhouse has to be anchored to its base in order to prevent damage.

Check whether you have all parts which are necessary for the assembly.

Please mind your own safety.

1. 2-3 persons are required for the assembly of this greenhouse.
2. Use protective clothing and gloves as some parts might be sharp.
3. During the assembly no children or pets should be present in the working area.
4. Do not stand on the roof with all your weight.
5. For better strength and durability we recommend to seal the transition between construction and polycarbonate with silicone (silicone is not part of the delivery).

Care and maintenance:

1. Clean the greenhouse using cloth and water
2. In case of snowfall remove the snow from the roof regularly.

The English version of the manual is an exact translation of the original manufacturer's instructions. Images used in this manual are for illustrational purposes only and may differ from the actual product.



Vielen Dank für den Kauf unseres Produktes.

Bevor Sie dieses Gerät verwenden, lesen Sie diese Anleitung.

Montageanleitung:

Vor der Montage lesen Sie bitte alle Anweisungen und Angaben vorsichtig. Das Glashauss muss auf dem Fundament verankert sein um eine Beschädigung zu verhindern.

Überprüfen Sie, ob alle Teile, die für die Montage notwendig sind, vorhanden sind.

Bitte beachten Sie zu Ihrer eigenen Sicherheit.

1. Für die Montage dieses Glashauss sind 2-3 Personen erforderlich.
2. Tragen Sie Schutzkleidung und Arbeitshandschuhe, da einige Teile scharfe Kanten haben können.
3. Während des Zusammenbaus sollten sich keine Kinder oder Tiere im Arbeitsbereich aufhalten.
4. Sie sollten sich nicht mit ihrem vollen Gewicht auf das Dach stellen.

Wartung und Pflege:

1. Reinigen Sie das Glashauss mit Putzlappen und Wasser.
2. Bei Schneefall entfernen Sie regelmäßig den Schnee vom Dach.

Die deutsche Version der Anleitung ist eine genaue Übersetzung der Anleitung des Herstellers. Die in diesem Handbuch verwendeten Bilder dienen nur zur Illustration und können nicht genau das Produkt entsprechen.



Děkujeme za nákup našeho výrobku.

Před použitím si prosím přečtěte tento návod.

Montážní návod:

Dříve, než začnete s montáží, pečlivě si prostudujte všechny pokyny a informace. Skleník musí být řádně ukotven k základové desce, aby nedošlo při silném větru k jeho poškození nebo zničení.

Zkontrolujte, zda máte všechny potřebné díly pro stavbu skleníku.

Dbejte na svoji bezpečnost.

1. Skleník montujte ve 2-3 lidech.
2. Při montáži použijte ochranný oděv a rukavice, protože některé části mohou být ostré.
3. V době montáže by se po staveništi neměly pohybovat děti a domácí zvířata.
4. Nikdy nestůjte na střeše celou svou vahou.
5. Pro lepší pevnost a odolnost skleníku doporučujeme přechody mezi konstrukcí a polykarbonátem utěsnit silikonem (není součástí dodávky).

Péče a údržba:

1. Skleník čistěte za pomoci hadru a vody.
2. V případě sněžení pravidelně odklízejte ze střechy skleníku napadaný sníh.

Česká verze návodu je přesným překladem originálního návodu výrobce.

Fotografie použité v manuálu jsou pouze ilustrační a nemusí se přesně shodovat s výrobkem.



Ďakujeme za nákup nášho výrobku.

Pred použitím si prosím prečítajte tento návod.

Návod na montáž:

Pred montážou si pozorne prečítajte všetky pokyny a informácie. Skleník musí byť riadne ukotvený k základnej doske, aby pri silnom vetre nedošlo k jeho poškodeniu alebo zničeniu.

Skontrolujte, či máte všetky potrebné diely na stavbu skleníka.

Dbajte na svoju bezpečnosť.

1. Na montáž skleníka sú potrebné 2-3 osoby.
2. Pri montáži používajte ochranný odev a rukavice, pretože niektoré časti môžu byť ostré.
3. Počas montáže by sa v pracovnom prostredí nemali pohybovať deti ani domáce zvieratá.
4. Nikdy nestojte na streche celou svojou váhou.
5. Pre lepšiu pevnosť a odolnosť skleníku odporúčame prechody medzi konštrukciou a polykarbonátom utesniť silikónom (nie je súčasťou balenia).

Starostlivosť a údržba:

1. Skleník čistíte pomocou handry a vody.
2. V prípade sneženia pravidelne zo strechy skleníka odstraňujte napadaný sneh.

Slovenská verzia návodu je presným prekladom originálneho návodu výrobca.

Fotografie použité v návode sú len ilustračné a nemusia sa presne zhodovať s výrobkom.



Köszönjük, hogy megvásárolta termékünket.

Használat előtt kérjük olvassa el a használati útmutatót.

Telepítési útmutató:

Telepítés előtt figyelmesen olvassa el az összes utasítást és információt. A üvegházhatású szilárdan és stabilan, egy alapra kell rögzíteni, hogy az erős szélben ne mozduljon el, vagy esetleg ne menjen tönkre. Az összeszerelés előtt ellenőrizze, hogy megvan-e minden alkatrész.

Ügyeljen a biztonságra

1. A üvegházhatású összeszereléséhez legalább 2-3 ember kell.
2. Telepítés közben vegyen fel védőöltözetet és kesztyűt, mert néhány alkatrész éles lehet.
3. A szerelés közben se gyermek, se háziállat ne tartózkodjon a közelben.
4. Soha ne nehezedjen a tetőre teljes súllyal.
5. A jobb szilárdság és tartósság érdekében ajánljuk a polikarbonát lemezek közötti átmeneteket kitölteni szilikonnal (nem tartozék).

Ápolás és karbantartás:

1. A üvegházhatású ronggyal és vízzel tisztítsa.
2. Havazás esetén mindig söpörje le a üvegházhatású a tetőről.

A magyar használati utasítás a gyártótól kapott verzió pontos fordítása.

A kézikönyvben használt fényképek csak illusztrációk, nem egyeznek meg pontosan a termékkel.



Dziękujemy za zakup naszego produktu.

Przed użyciem prosimy starannie przeczytać tę instrukcję.

Instrukcja montażu:

Przed przystąpieniem do montażu należy dokładnie zapoznać się z zaleceniami i informacjami. Ciepłarnianych musi być prawidłowo umocowany do płyty fundamentowej, aby przy silnym wietrze nie doszło do jego uszkodzenia lub zniszczenia.

Należy sprawdzić kompletność wszystkich elementów niezbędnych do budowy ciepłarnianych.

Należy zadbać o własne bezpieczeństwo.

1. Ciepłarnianych powinien być montowany przez ekipę składającą się z 2-3 pracowników.
2. Podczas prac montażowych należy korzystać z odzieży ochronnej i rękawic dlatego, że niektóre z części mogą mieć ostre krawędzie.
3. Podczas prac montażowych na placu budowy niepożądana jest obecność dzieci i zwierząt domowych.
4. Nigdy nie należy całą swoją wagą stać na dachu domu.

Pielęgnacja i konserwacja:

1. Do czyszczenia ciepłarnianych używać ścierki i wody.
2. W razie opadów śniegu, z dachu ciepłarnianych należy usuwać zalegający śnieg.

Polska wersja językowa instrukcji jest dokładnym tłumaczeniem oryginalnej instrukcji producenta.

Zdjęcia wykorzystane w tym podręczniku są jedynie ilustracją i nie może dokładnie dopasować produkt.

Installation

Montage

Montáž

Gyülekezés

Montaż



Tools you will need / Werkzeuge, die Sie brauchen / Nástroje, které budete potřebovat
Nástroje, ktoré budete potrebovať / Eszközökét akkor kell / Przystędy i narzędzia, które będą potrzebne

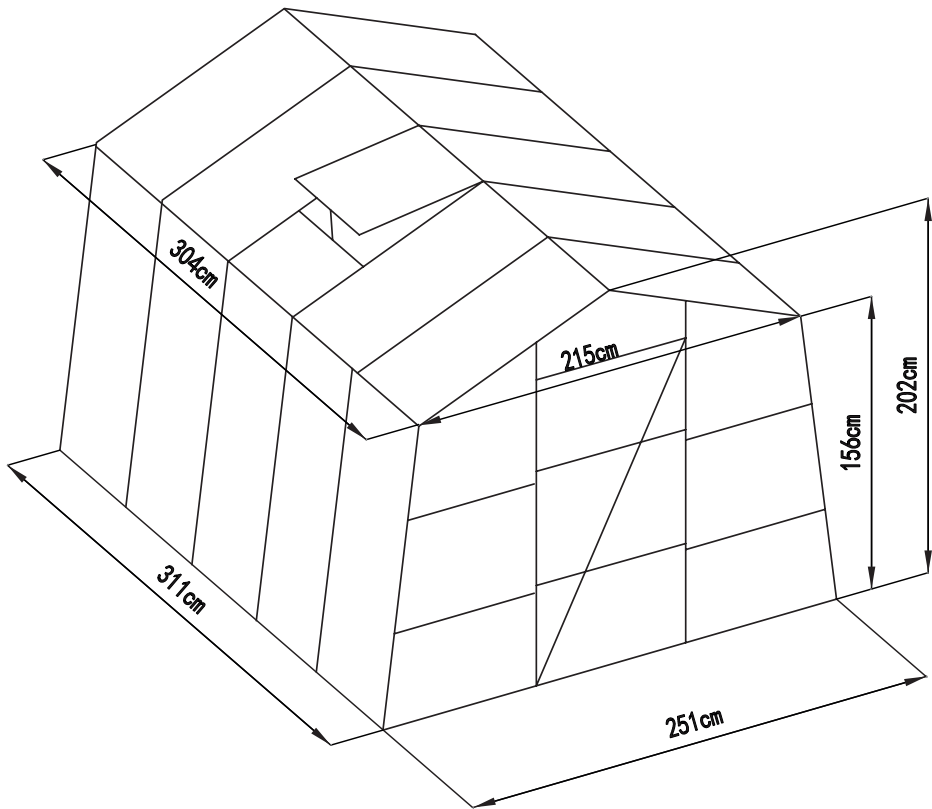
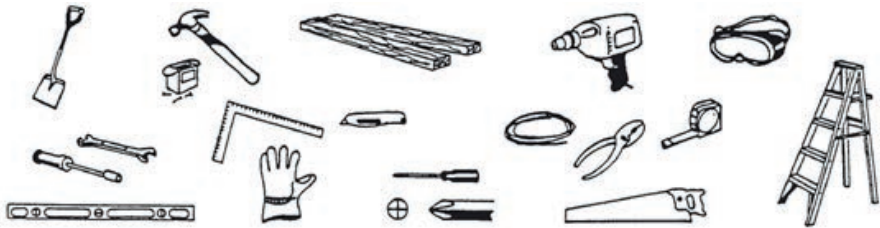

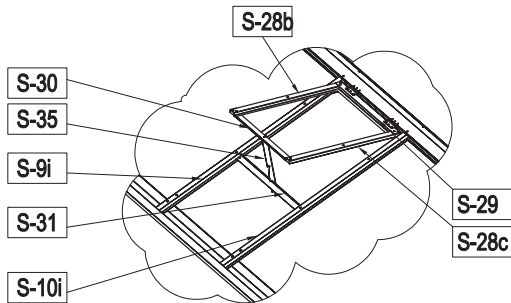
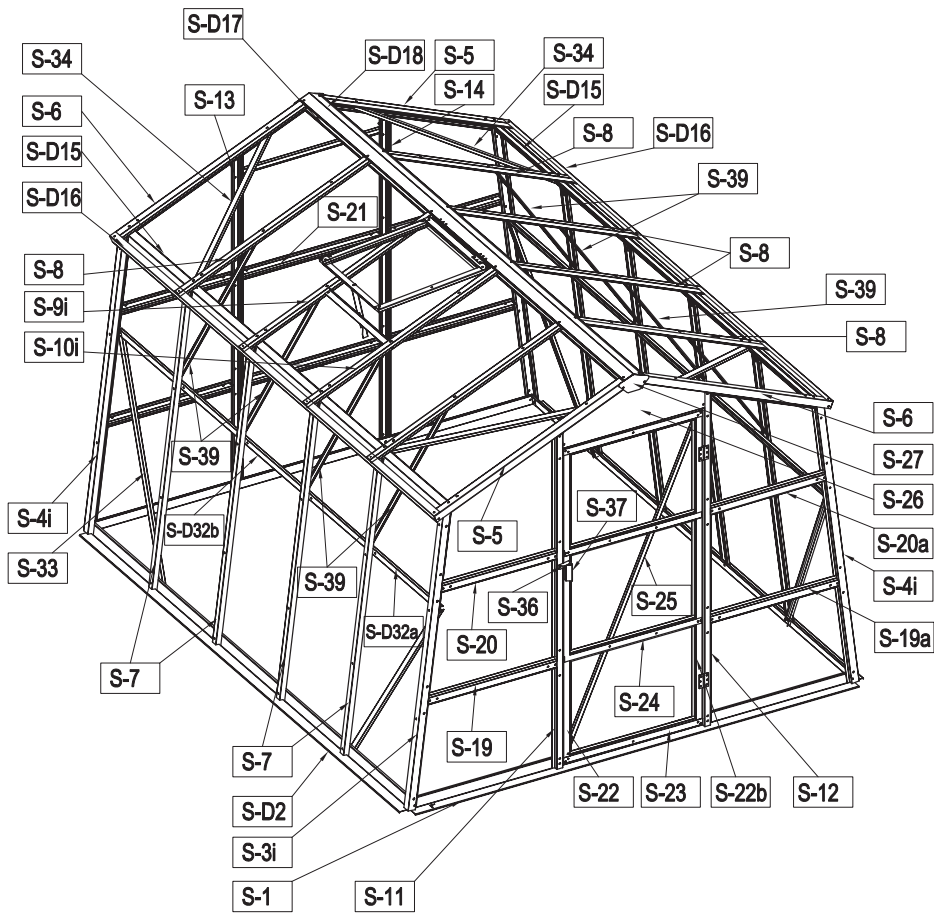
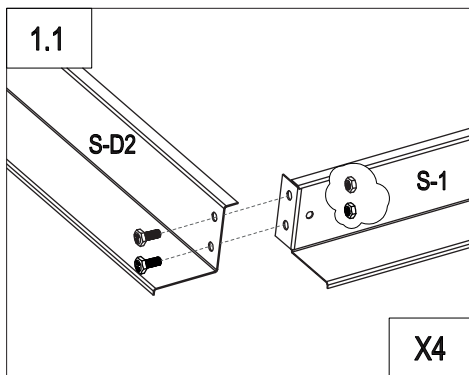
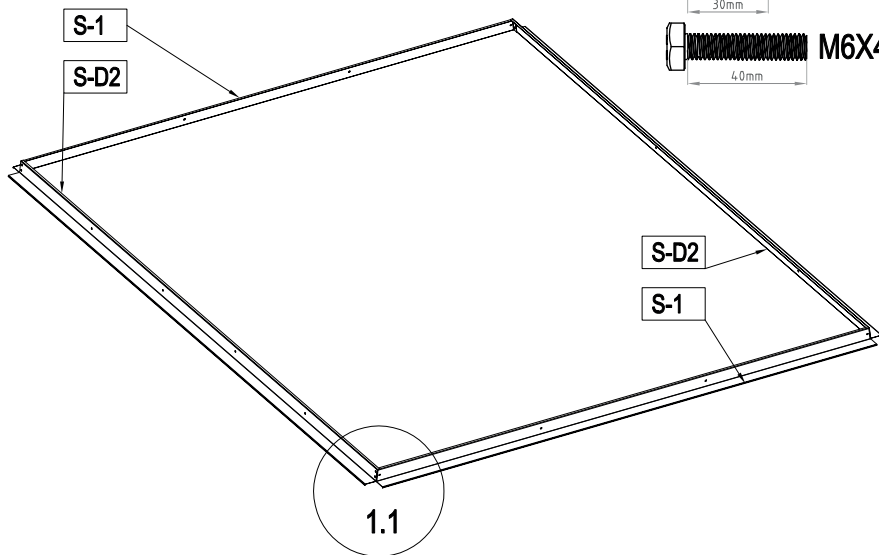
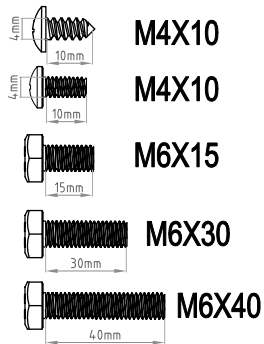
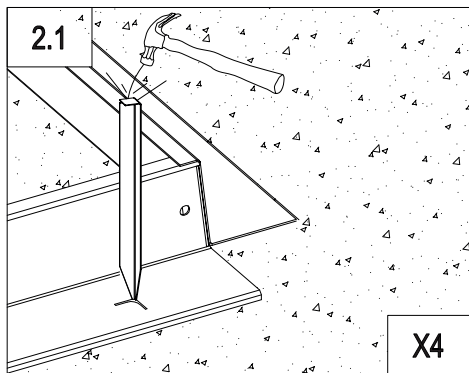
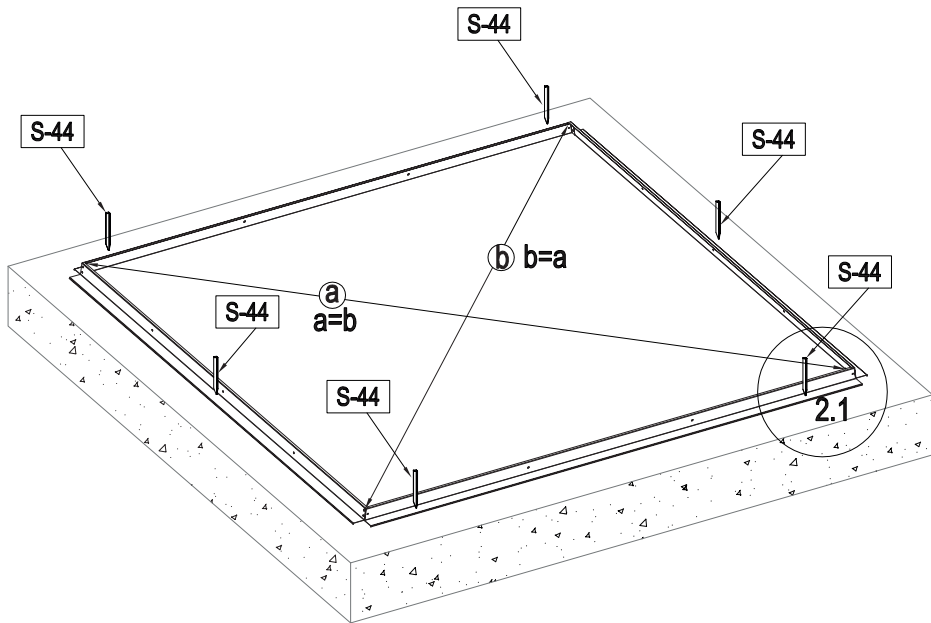

IMAGE	NO.	L.	QTY	IMAGE	NO.	L.	QTY
	S-1	2400	2		S-40		12
	S-D2	2998.5	2		S-41		24
	S-3i	1565	2		S-42		5
	S-4i	1565	2		S-43		1
	S-5	1145	2		S-44		6
	S-6	1145	2		S-45		4
	S-7	1565	8		S-46	530	6
S-8	1145	6	S-47		1530	8	
	S-9i	1145	1		S-49	1060	6
	S-10i	1145	1		S-48	1530	2
	S-11	1811.5	1		S-48a	1530	2
	S-12	1811.5	1		S-50	1060	3
	S-13	1811.5	1		S-50a	1060	3
	S-14	1811.5	1		S-51	530	14
	S-D15	3038.5	2		S-52	335	6
	S-D16	3038.5	2		S-53	520	2
	S-D17	3038.5	1		S-54		40
	S-D18	3038.5	1		M4X10		12
	S-19	698	2		M4X10		52
	S-19a	698	2		M6X15		159
	S-20	626	2		M6X30		60
	S-20a	626	2		M6X40		32
	S-21	768	2		PC-1		10
	S-22	1695	1		PC-2		9
	S-22b	1695	1		PC-3		1
	S-23	750	2		PC-4		1
	S-24	744	2		PC-5		2
	S-25	1772	1		PC-6		2
	S-26		2		PC-7		2
	S-27		2		PC-8		2
	S-28b	598.5	1		PC-9		2
	S-28c	598.5	1		PC-10		2
	S-29	555	1		PC-11		3
	S-30	551	1		PC-12		2
	S-31	566	1		PC-13		1
	S-D32a	1586	2				
	S-D32b	1526	2				
	S-33	1204	4				
	S-34	1028	4				
	S-35	300	1				
	S-36		1				
	S-37		1				
	S-38		1				
	S-39		8				





	M6X15	8
	S-1	2
	S-D2	2



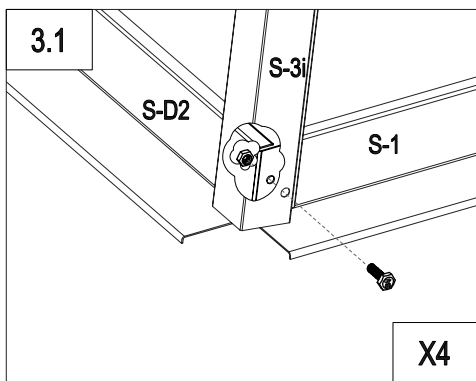
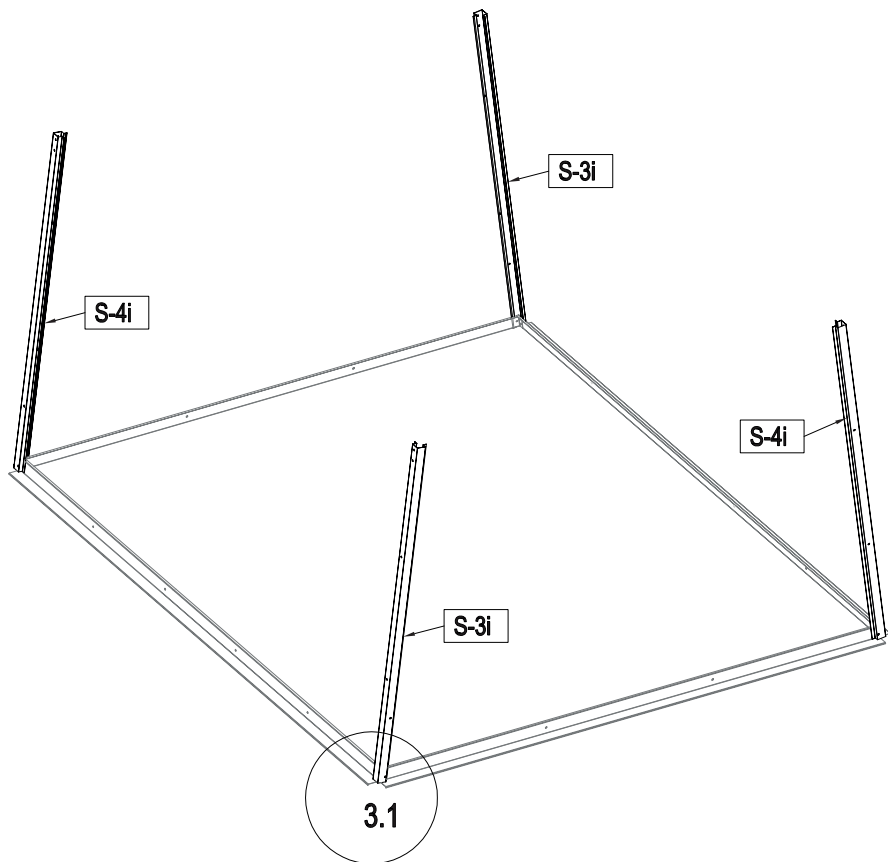



	S-44	6
--	------	---

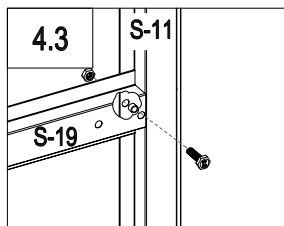
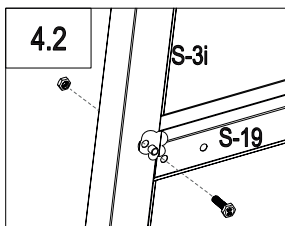
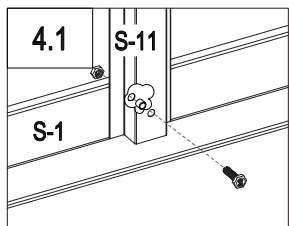
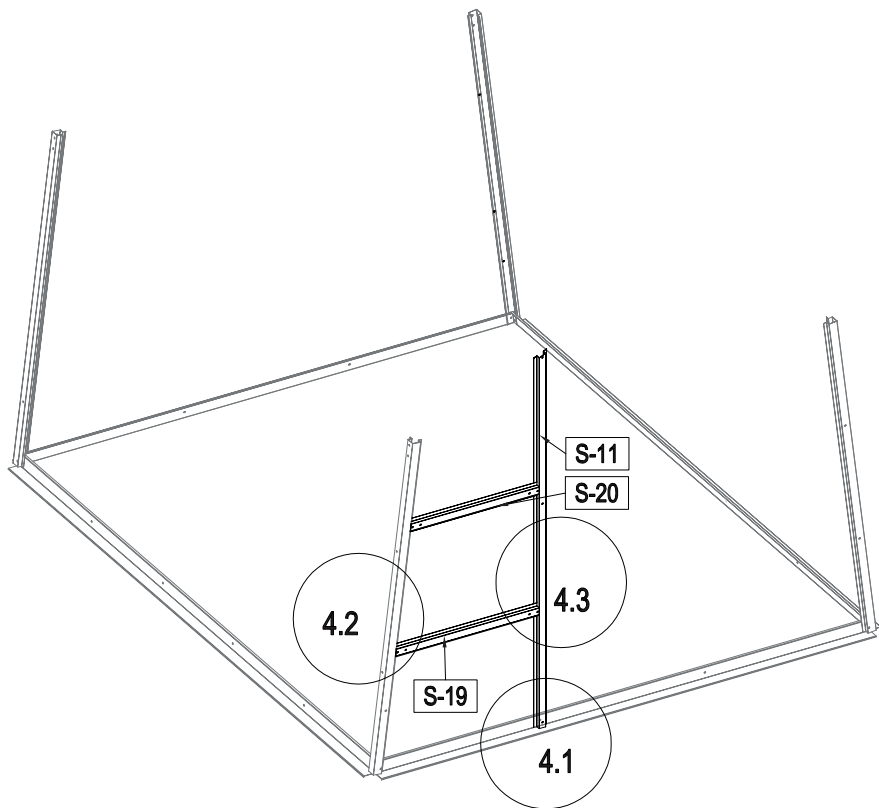

	M6X30	4
	S-3i	2
	S-4i	2





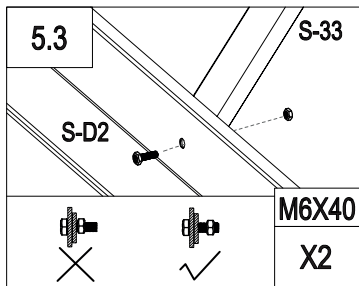
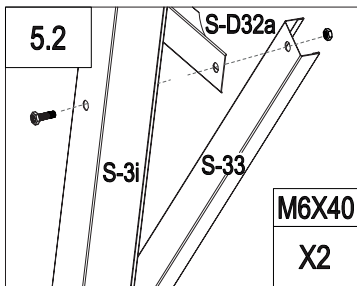
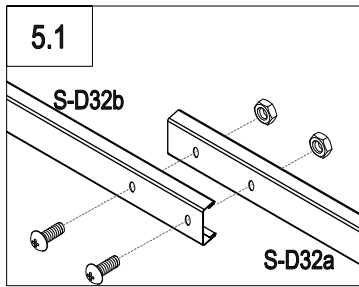
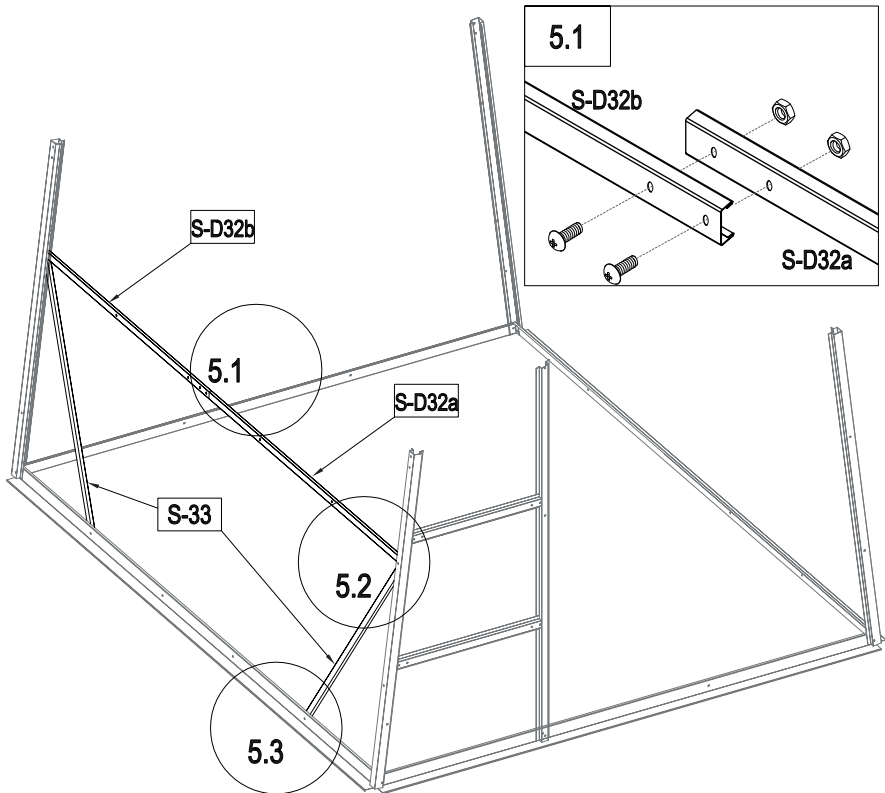

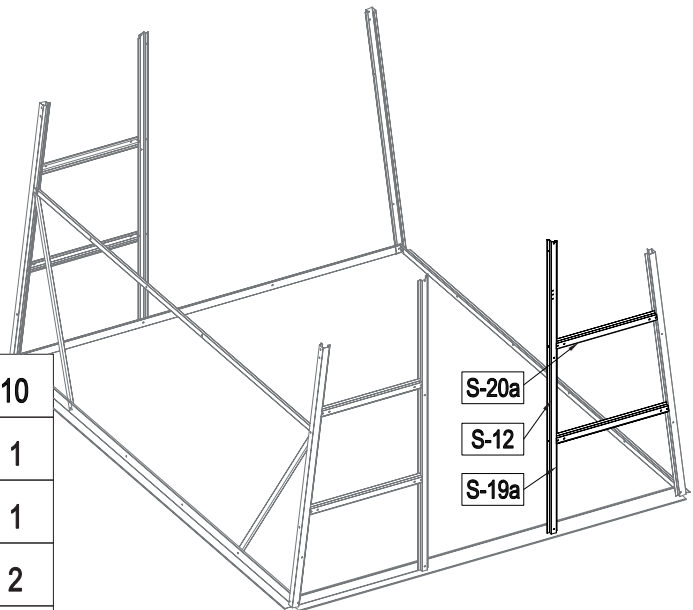
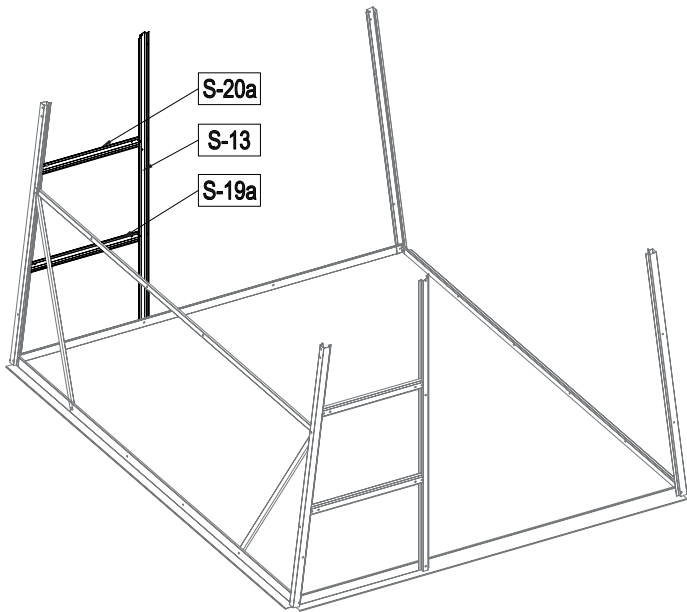

	S-54	5
	M6X30	5
	S-11	1
	S-19	1
	S-20	1









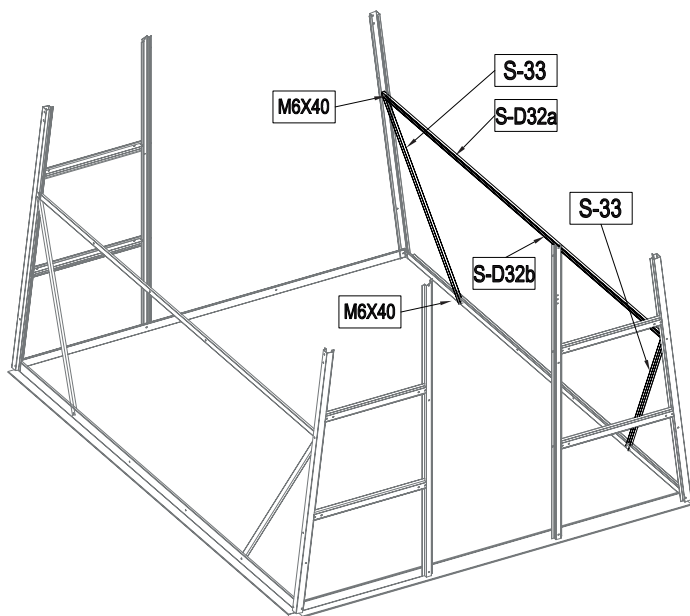



	M4X10	2
	M6X40	4
	S-D32a	1
	S-D32b	1
	S-33	2







	S-54	10
	S-12	1
	S-13	1
	S-19a	2
	S-20a	2
	M6X30	10

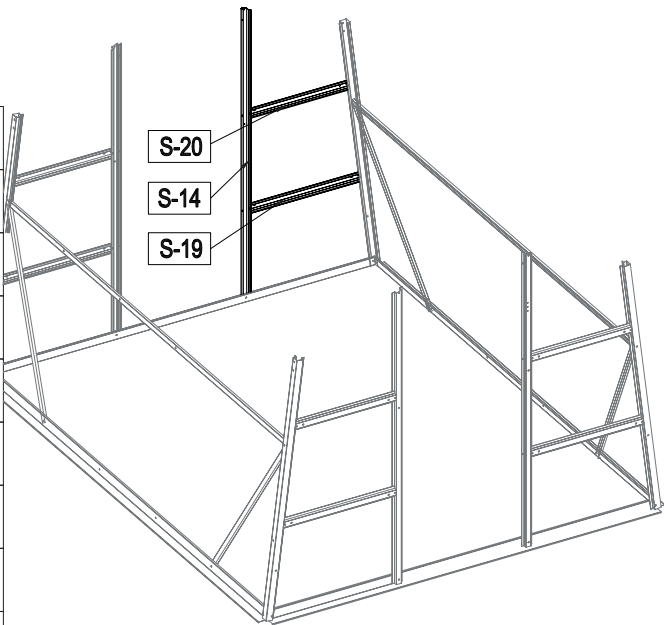

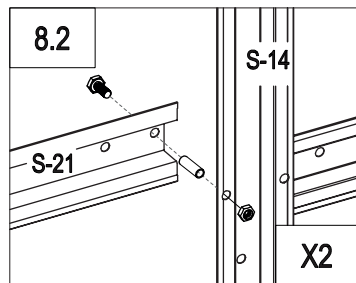
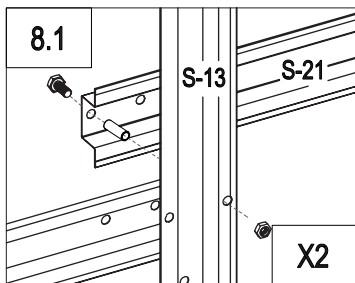
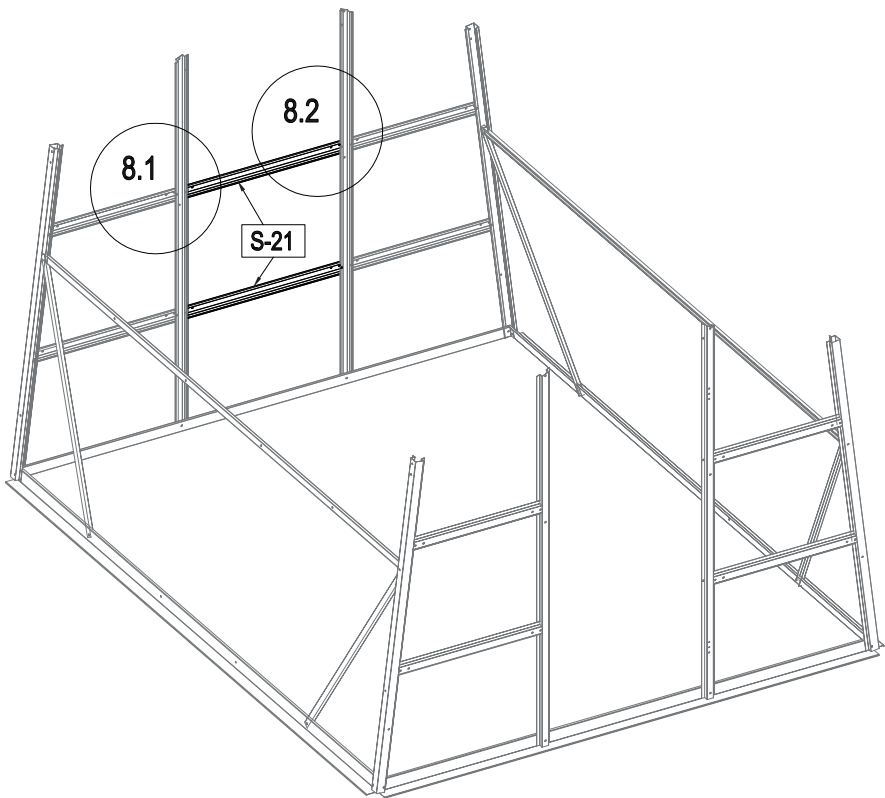
	S-54	5
	S-14	1
	S-19	1
	S-20	1
	S-D32a	1
	S-D32b	1
	S-33	2
	M6X40	4
	M6X30	5
	M4X10	2







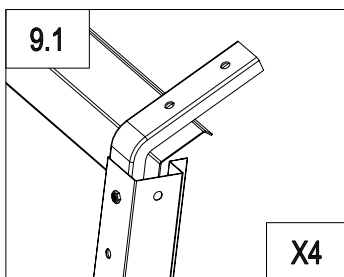
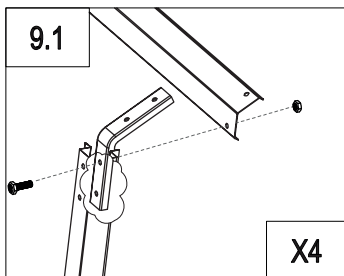
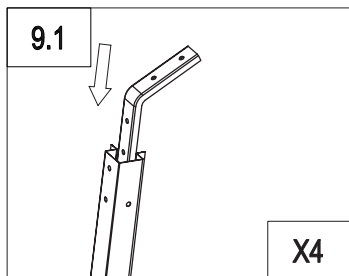
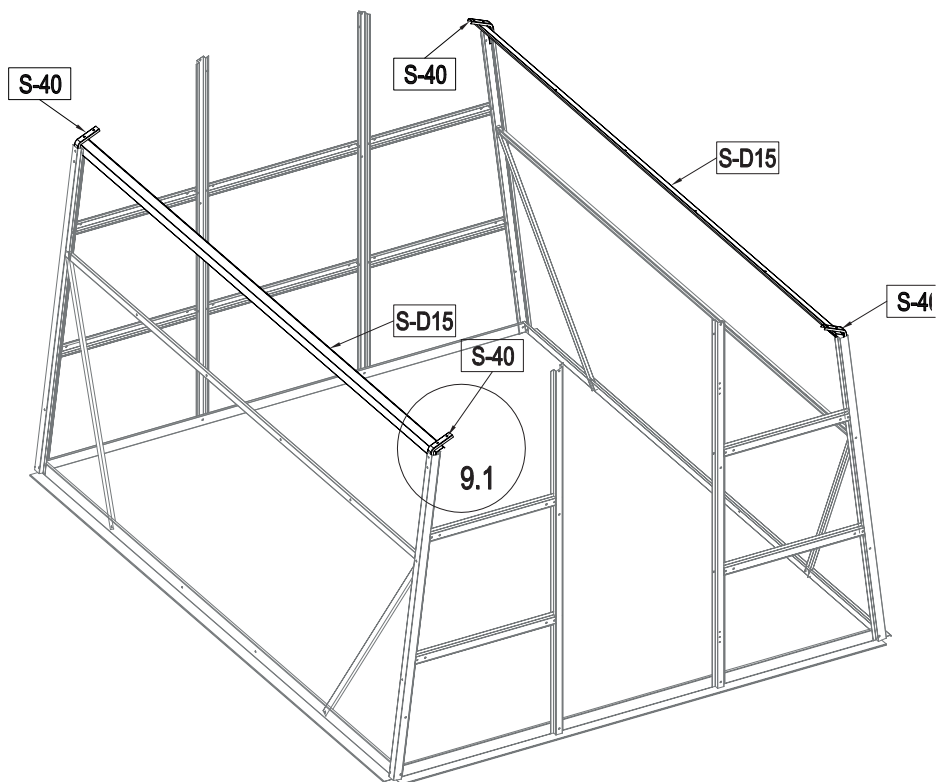

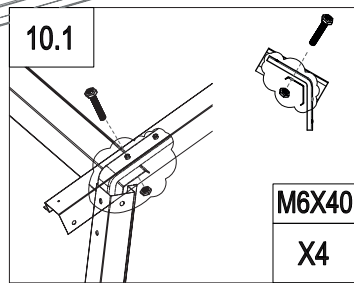
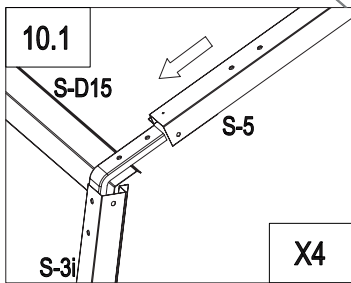
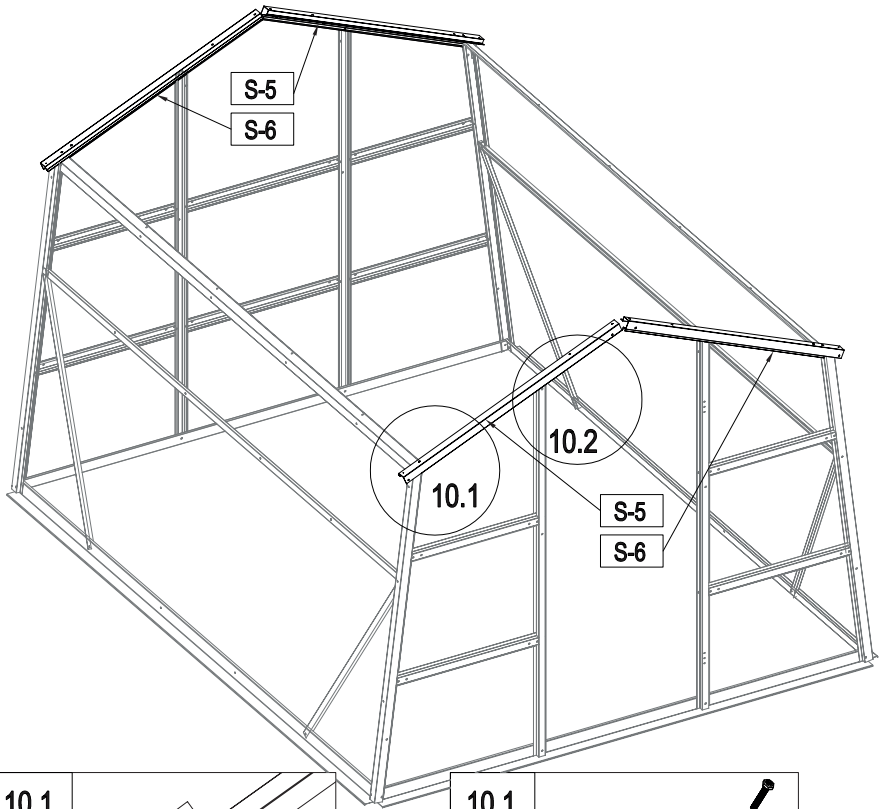

	S-54	4
	S-21	2
	M6X30	4







	S-D15	2
	S-40	4
	M6X30	4

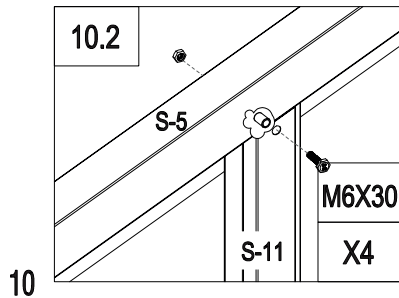

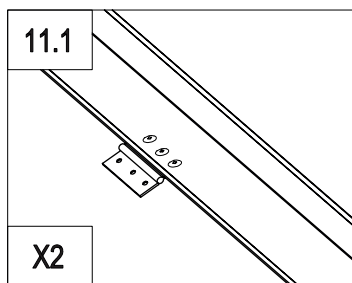
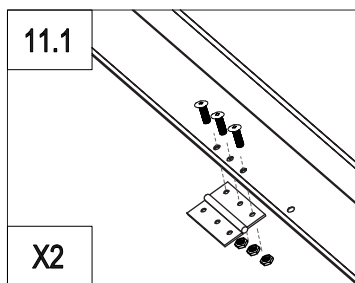
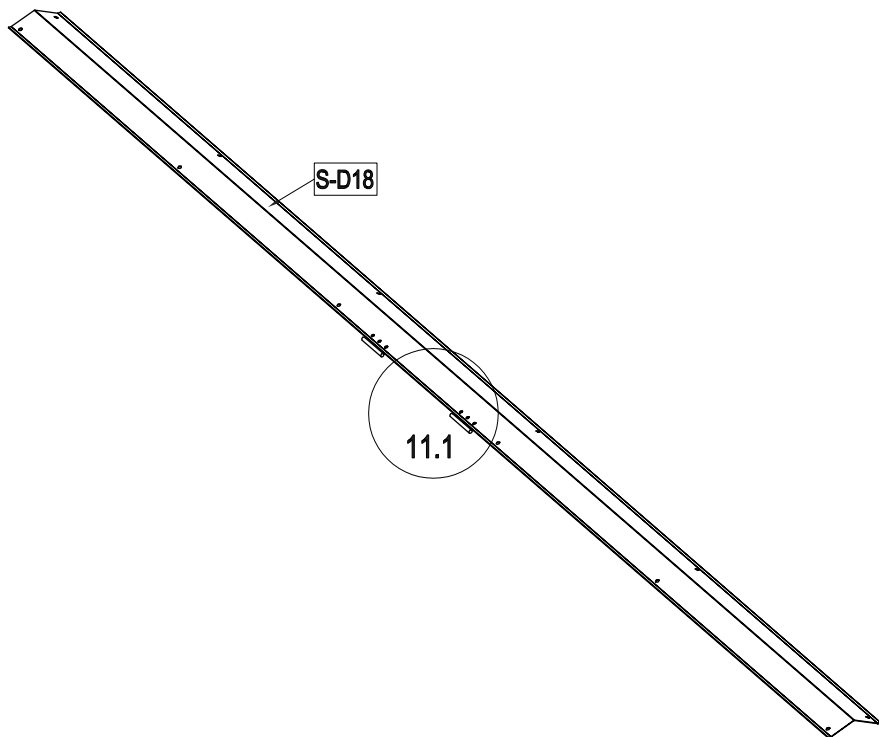



	S-54	4
	S-5	2
	S-6	2
	M6X40	4
	M6X30	4



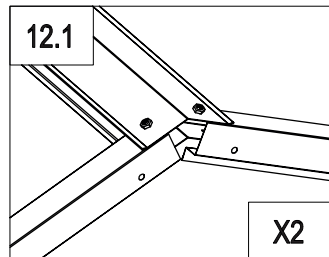
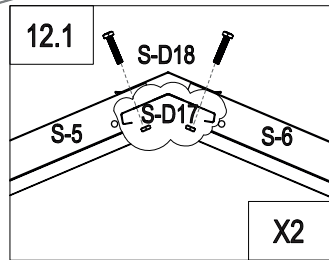
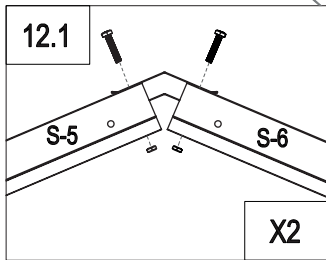
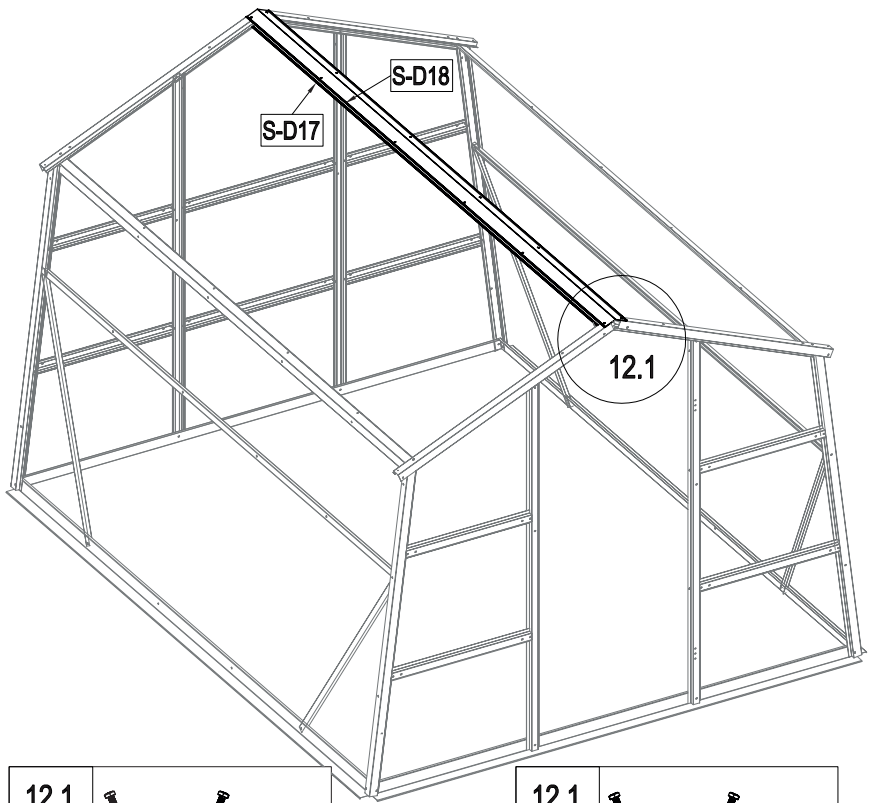

	M4X10	6
	S-45	2
	S-D18	1





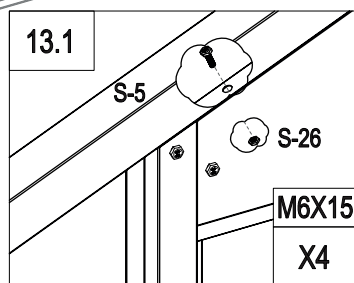
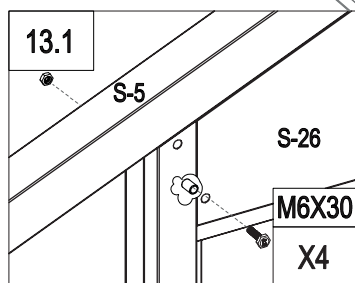
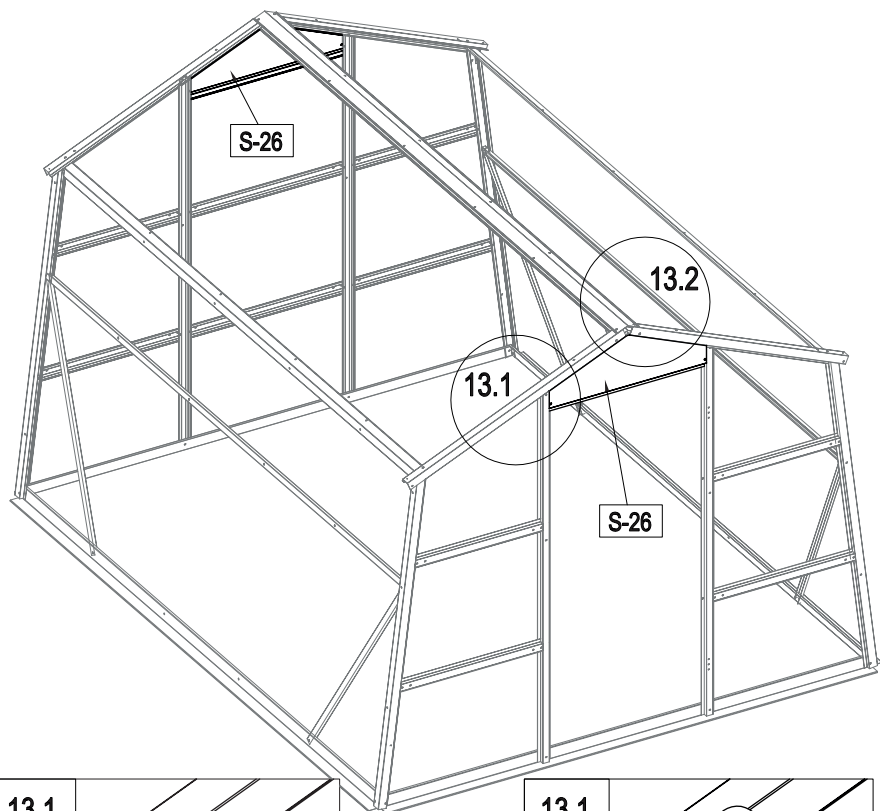

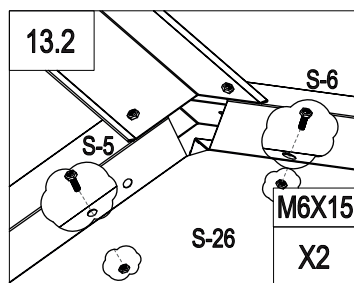

	S-D17	1
	S-D18	1
	M6X40	4

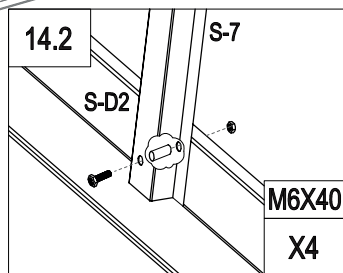
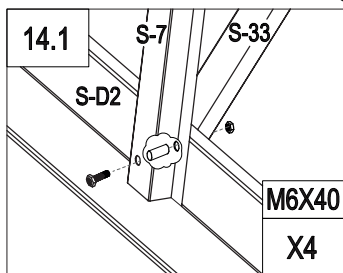
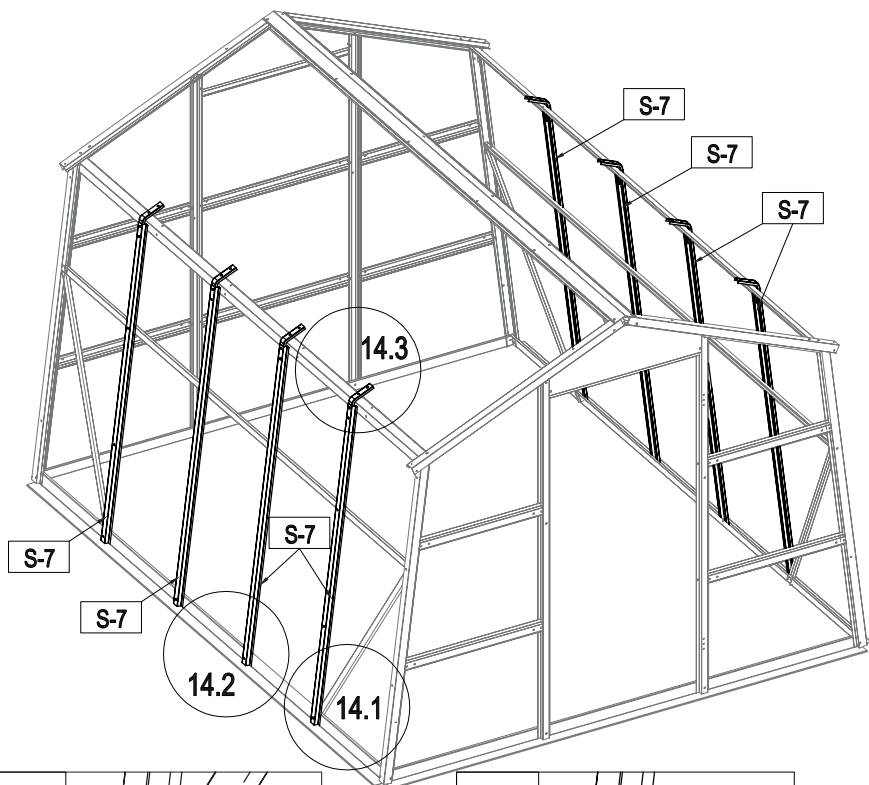

	S-54	4
	S-26	2
	M6X30	4
	M6X15	8





	S-54	8
	S-7	8
	S-40	8
	M6X40	4
	M6X30	8

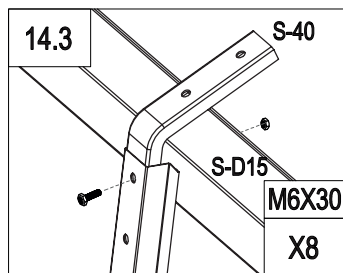

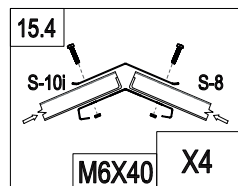
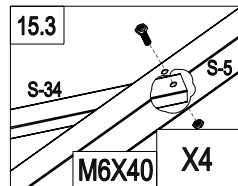
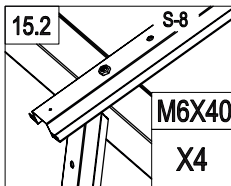
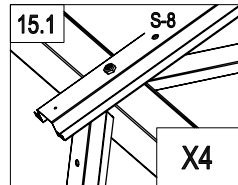
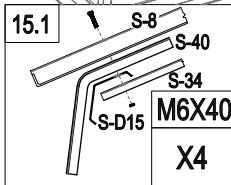
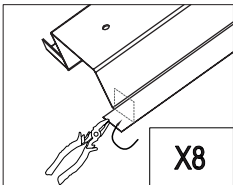
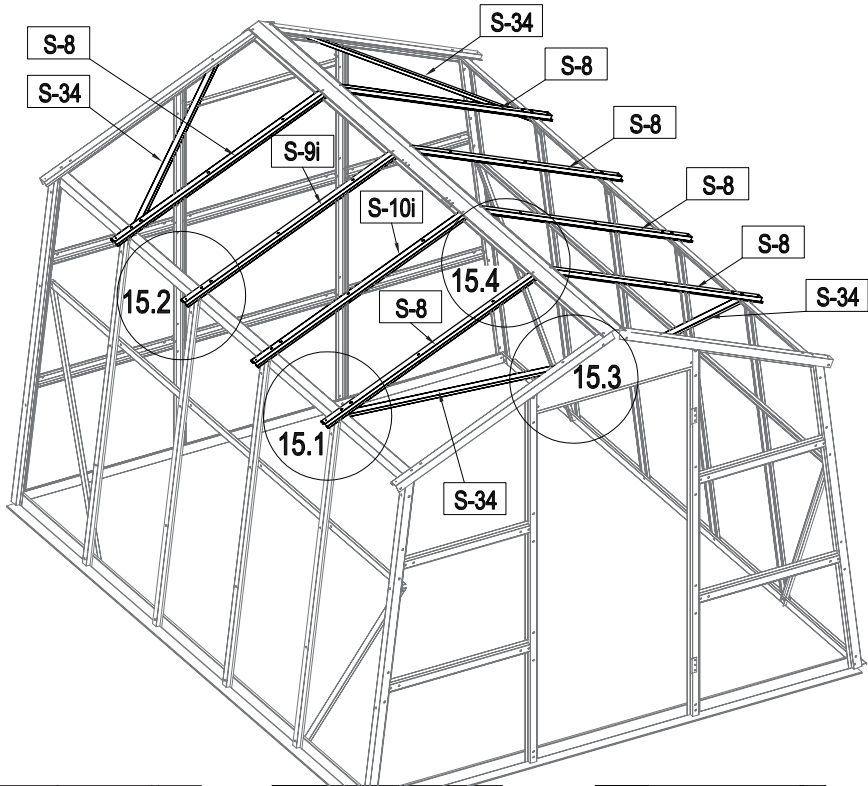



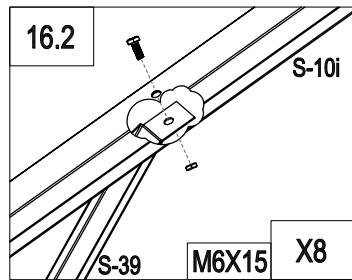
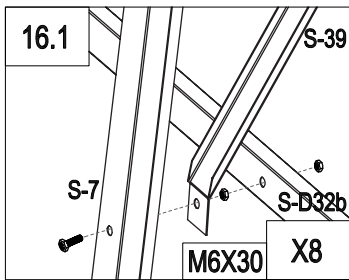
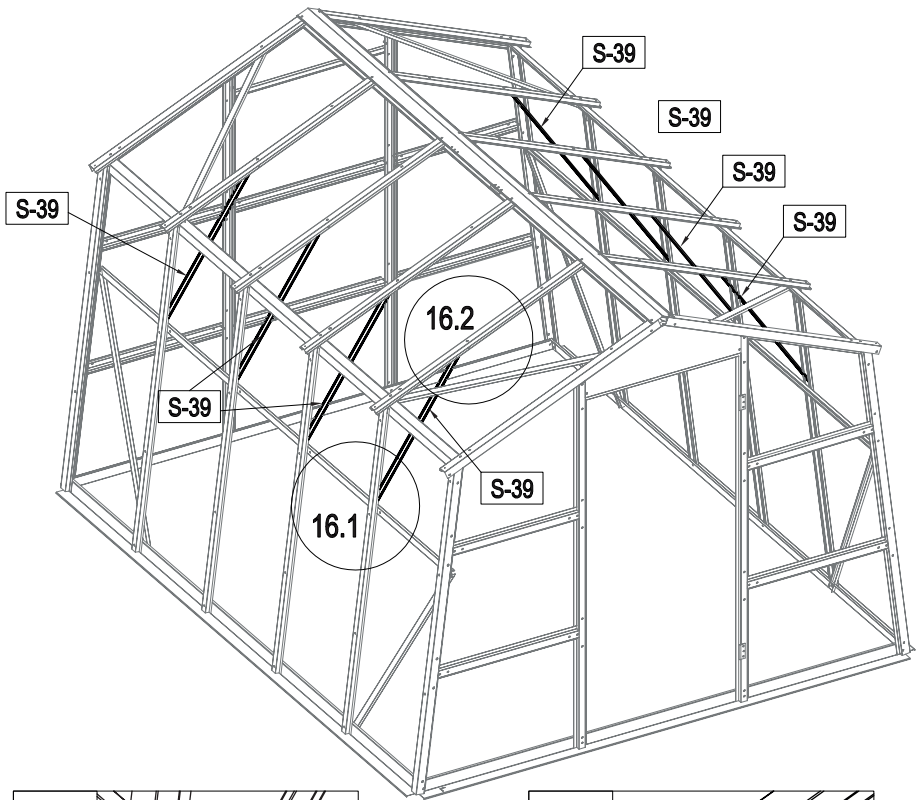

	S-8	6
	S-9i	1
	S-10i	1
	S-34	4
	M6X40	20

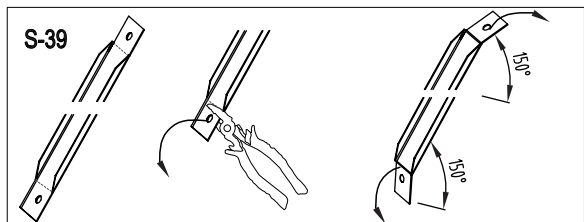

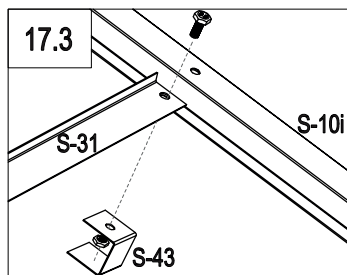
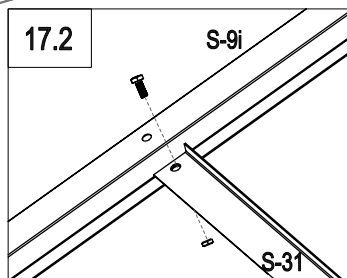
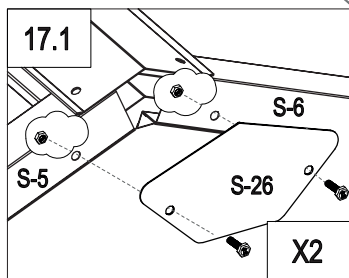
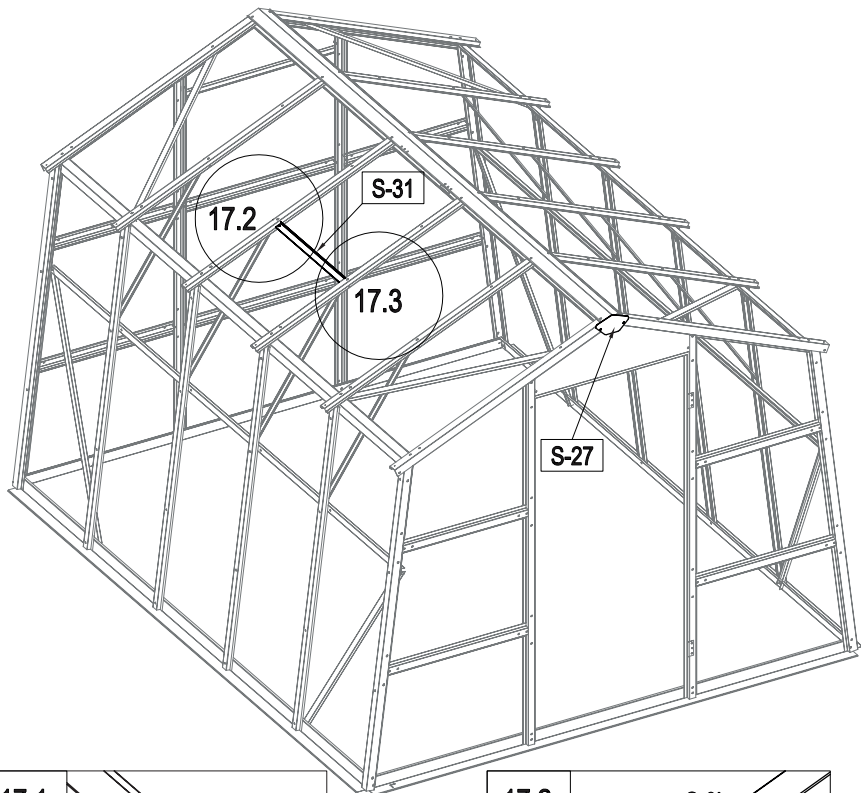
	S-39	8
	M6X15	8
	M6X30	8





	S-27	2
	S-31	1
	S-43	1
	M6X15	6

Door / Tür / Dveře / Dvere / Ajtók / Drzwi

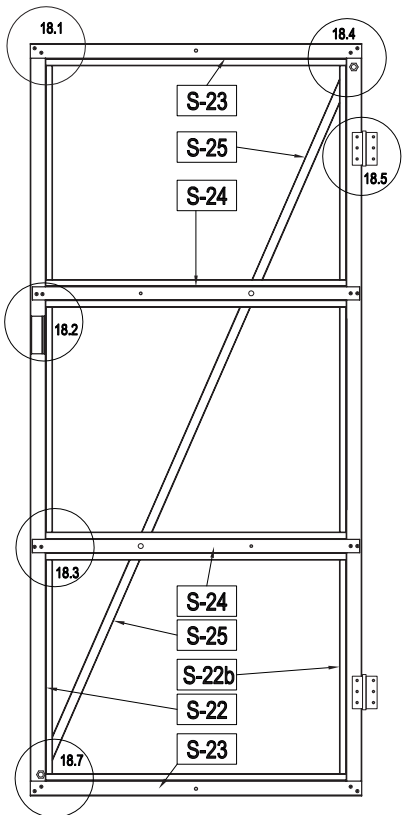
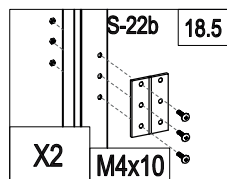
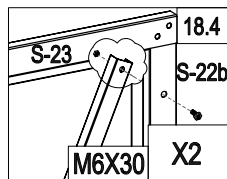
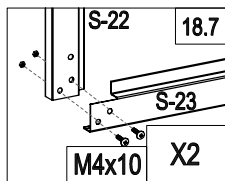
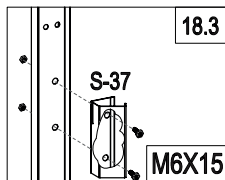
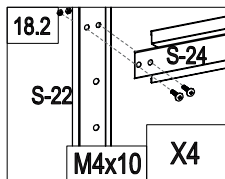
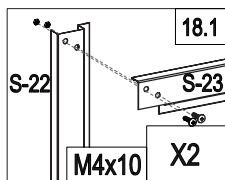

	S-22	1
	S-22b	1
	S-23	2
	S-24	2
	S-25	1

	M4X10	22
	M6X30	2
	S-45	2
	S-37	1

	M6X15	2
--	-------	---

18

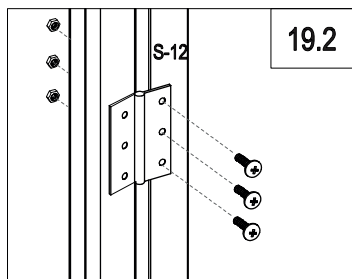
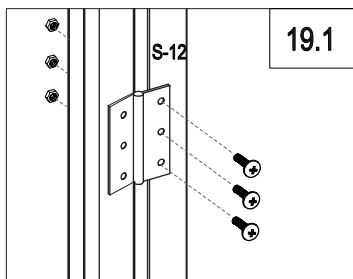
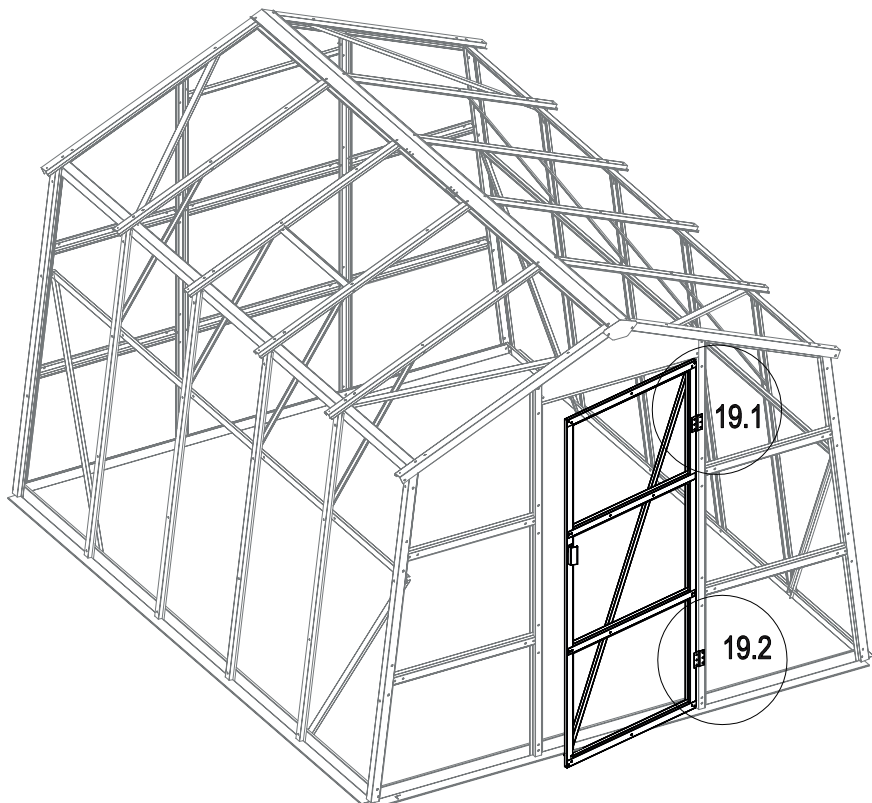

	M4X10	6
--	-------	---

Window / Fenster / Okno / Okno / Ablak / Okno

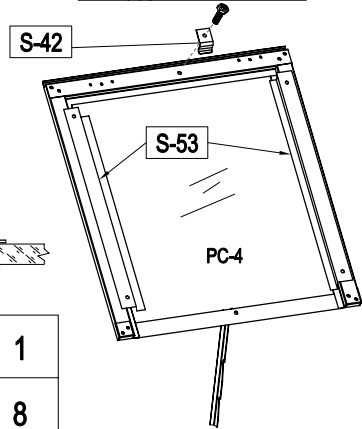
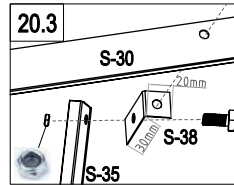
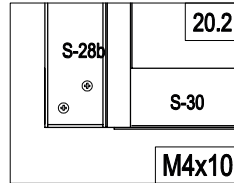
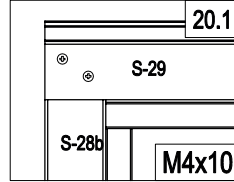
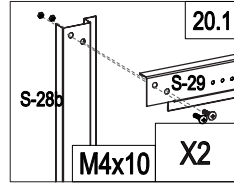
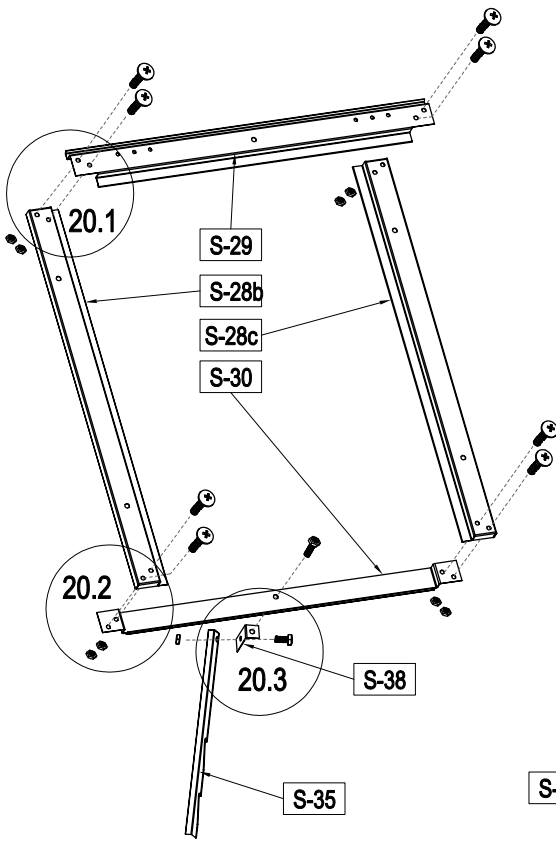

	S-28b	1
	S-28c	1
	S-29	1
	S-30	1
	S-35	1
	S-38	1

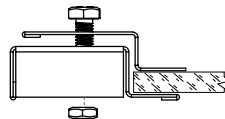

	S-42	1
	M4X10	8
	M6X15	7





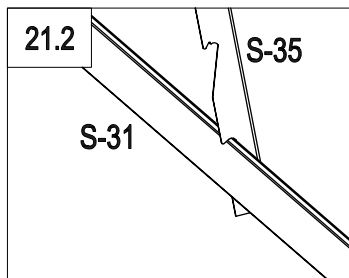
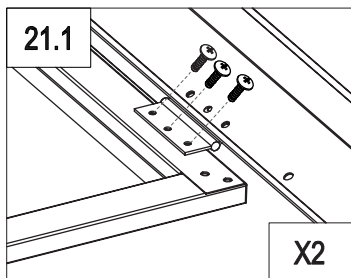
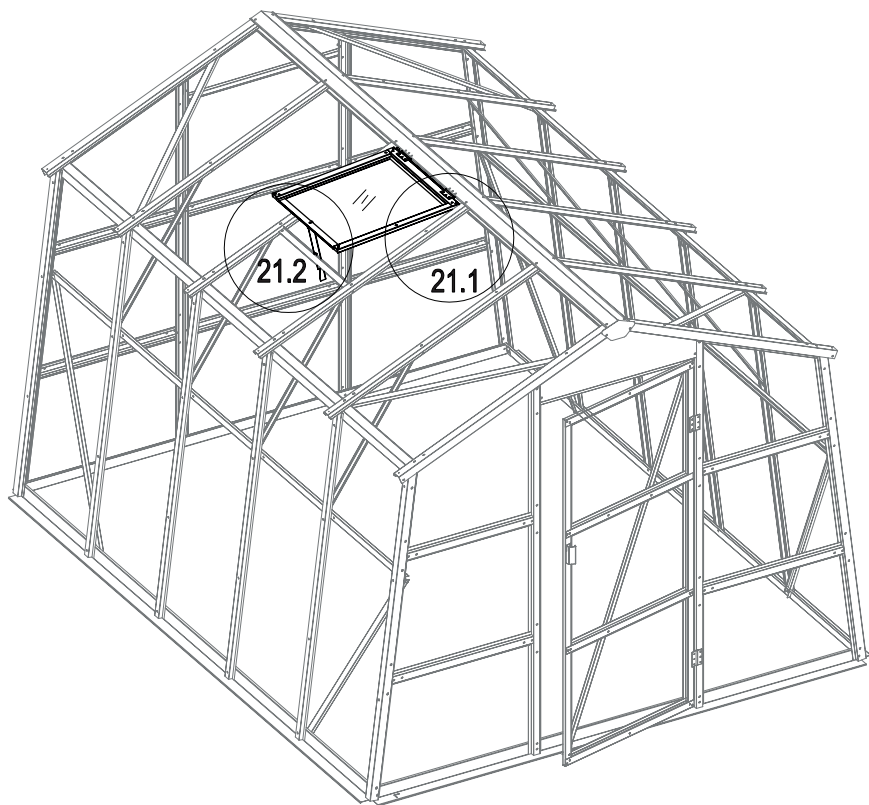



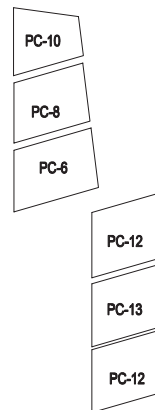
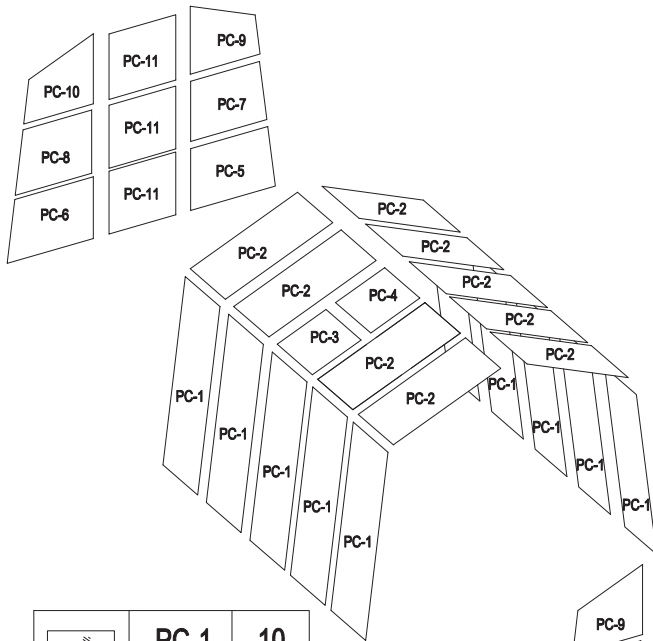

20



	S-53	2
	PC-4	1



	M4X10	6
--	-------	---



	PC-1	10
	PC-2	9
	PC-3	1
	PC-4	1
	PC-5	2
	PC-6	2
	PC-7	2
	PC-8	2
	PC-9	2
	PC-10	2

	PC-11	3
	PC-12	2
	PC-13	1

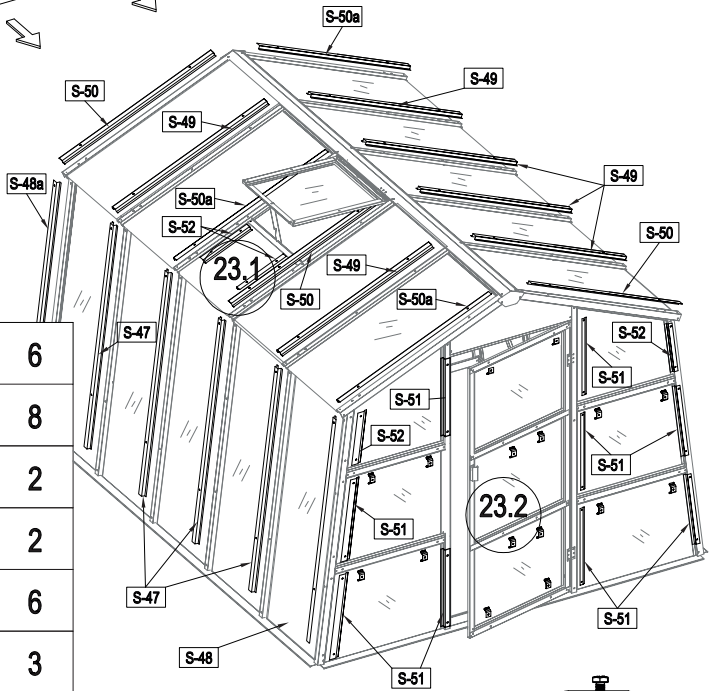
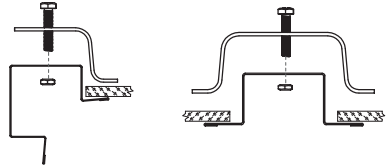
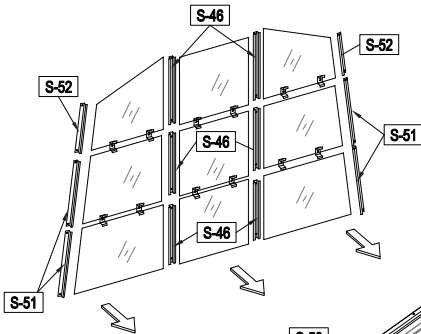

22

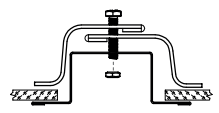
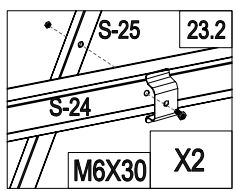
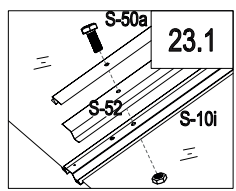

	S-46	6
	S-47	8
	S-48	2
	S-48a	2
	S-49	6
	S-50	3
	S-50a	3
	S-51	13
	S-52	6
	S-41	24
	S-42	4
	M6X15	122
	M6X30	2

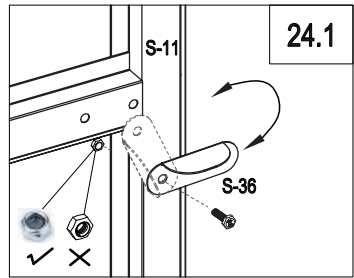
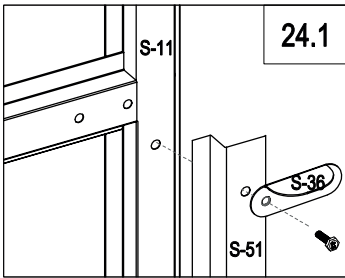
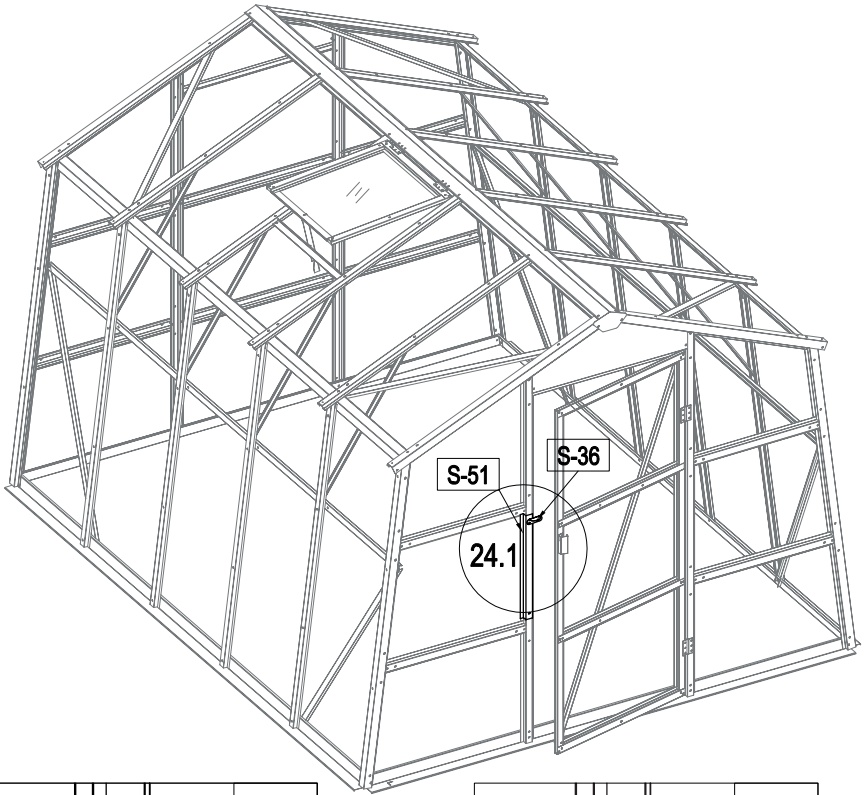



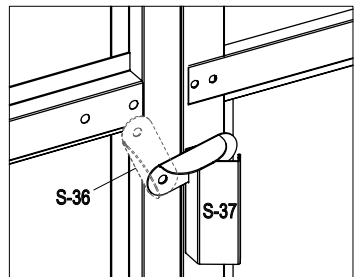

	S-51	1
	M6X15	2
	S-36	1

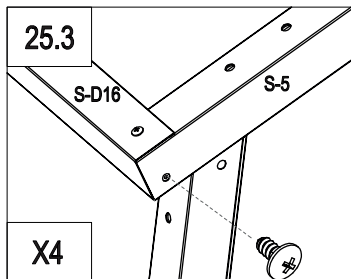
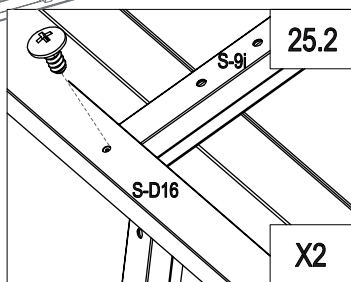
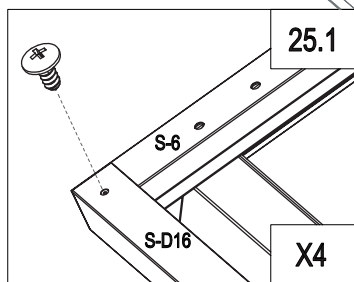
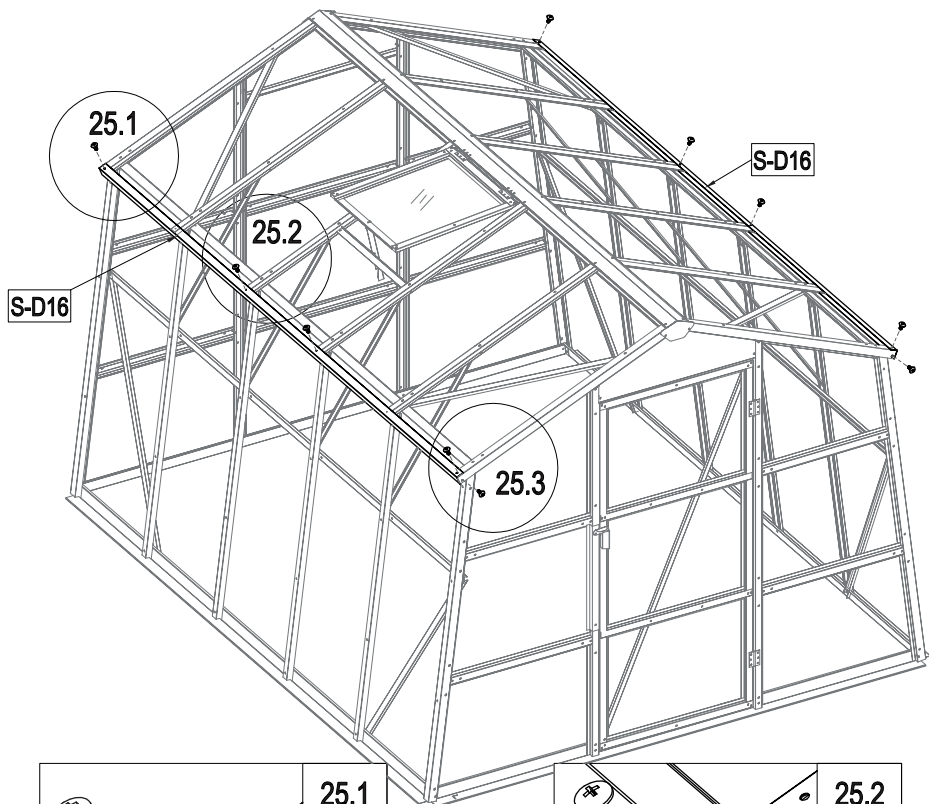



	S-D16	2
	M4x10	12

۲۷

